

REVISION HISTORY			
REV	DESCRIPTION	DATE	APPROVED

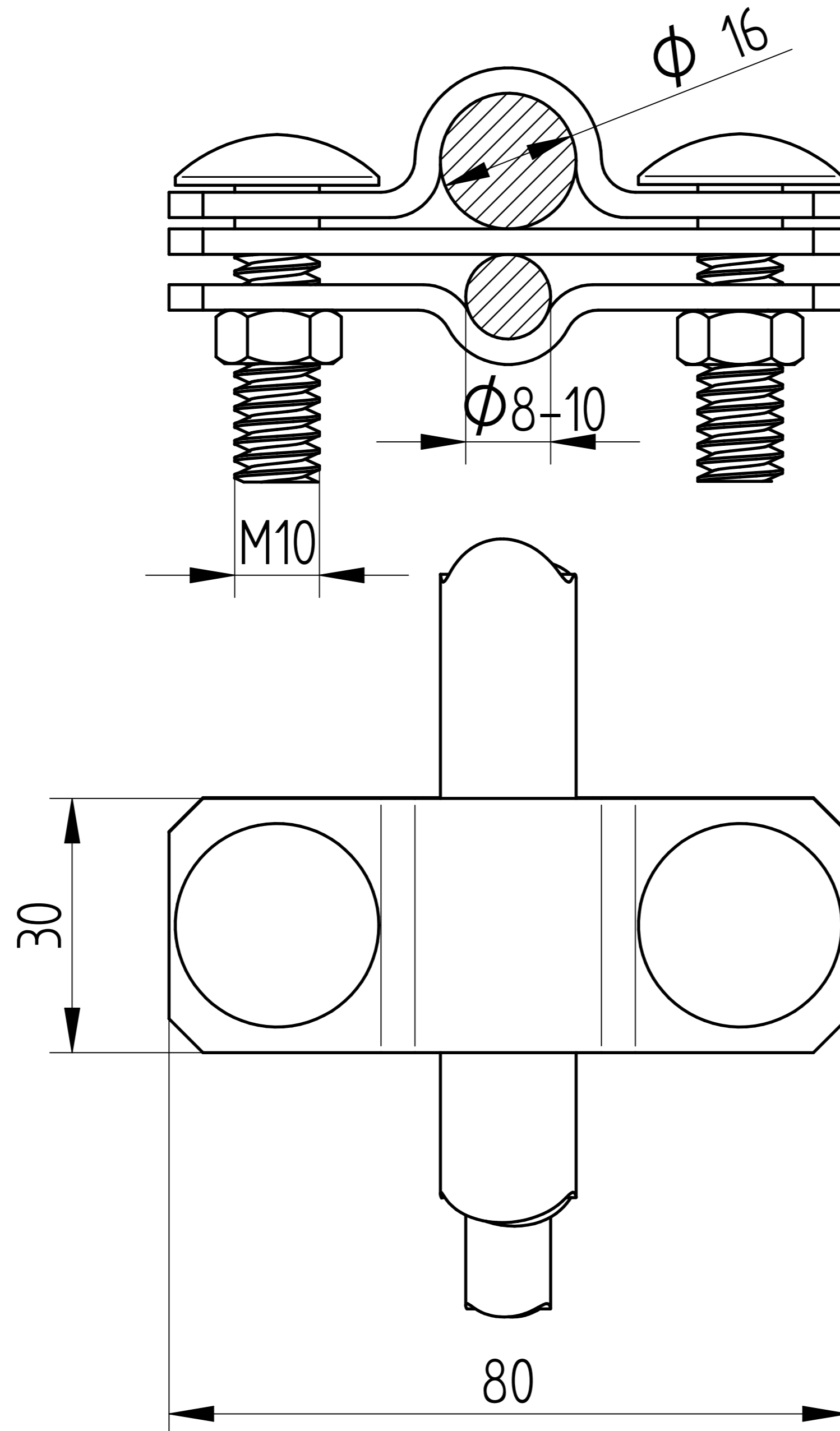

SOLID EDGE ACADEMIC COPY

	NAME	DATE	Solid Edge	
DRAWN	Gromtor	06/16/21	TITLE	
CHECKED			SIZE	DWG NO
ENG APPR			A2	
MGR APPR			FILE NAME:	1101.dft
UNLESS OTHERWISE SPECIFIED DIMENSIONS ARE IN MILLIMETERS ANGLES ±X.X° 2 PL ±X.XX 3 PL ±X.XXX			SCALE:	WEIGHT:
			SHEET	1 OF 1